

OPTIONS

Bin top

- soft wood
- hardwood of European origin
- hard wood (oil finish)
- premium hard wood
- HPL
- carbon steel (s235Jr)
- stainless steel (Aisi 304)

Methods of installation

- embedded in concrete
- attached by bolts to foundation

Container

- galvanized steel container

DESCRIPTION

Scandik's modern **recycling bins** for **segregated waste**. To choose from we have Two-chamber, three-chamber, four-chamber and five-chamber models. The inscription on the canopy of the basket can be freely personalized, so the baskets can be used for any type of waste.

The structure of the basket is made of steel, while the canopy can be made of wood, HPL or also steel. We can choose between stainless steel or carbon steel, galvanized and painted in the RAL colour of your choice. The wood is either coniferous - national wood or exotic wood. You can find examples of the colouring of sample wood here. Inside each bin chamber there is a galvanized sheet metal insert, which makes the replacement of the waste bag simple and easy.

Scandik recycling bins are part of the Scandik product line, includes furniture such as: benches, planters, and **solar station**.

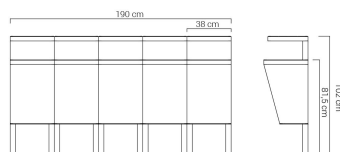
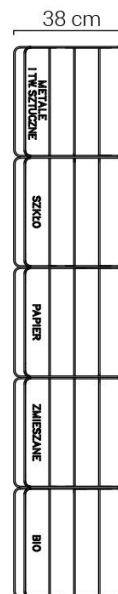
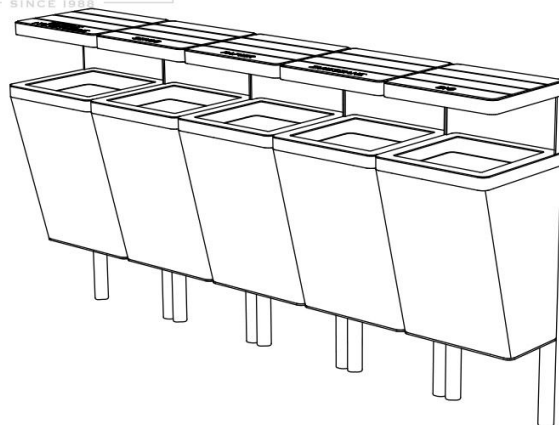

GENERAL TECHNICAL DATA

Weight

- 200 kg

Dimensions

- width: 190 cm
- height: 102 cm
- depth: 38 cm

Materials

- carbon steel or stainless steel

ZANO



Iwona Żaczek

Product:
Recycling bin Scandik
Catalog number: 15.546
Designer: Iwona Żaczek

In accordance with the Polish Law on Copyright and Related Rights of 04.02.1994 (Official Journal of Laws No. 24, item 83, corrected: Journal of Laws No. 43, item 170) and in accordance with the EU copyright legislation including all EU directives and regulations on copyright, Zano Mirosław Zarotynski Company, reserves the copyright of drawings, descriptions, 3D models, renderings, graphics, content contained in offers, attachments to offers and all other documents. Its content is the intellectual property of ZANO Mirosław Zarotynski company. The use of author's ideas, solutions, copying, distribution of photos, graphics or fragments of graphics, descriptive texts, for profit, without the permission of the author - ZANO Mirosław Zarotynski company - is prohibited and constitutes a copyright infringement and is punishable.

NOTE: The drawings do not reflect the actual dimensions of the foundation. They are only exemplary assembly schemes taking into account the type of anchoring and the substrate material to which the furniture is to be fixed.

The size of the foundation depends on the local foundation conditions.



INSTALLATION INTO PAVING WITH FOUNDATION

Description of the assembly

1. ZANO product
2. Stone paving / concrete paving / stone slabs / concrete slabs
3. Sand ballast (approx. 2 - 4 cm)
4. Concrete foundation, class C16/20 (top surface concrete 10 cm below paving surface)
5. Ground



MOUNTING TO CONCRETE FOUNDATION

Description of the assembly

1. ZANO product
2. Concrete foundation, class C16/20 (top surface concrete 10 cm below paving surface)
3. Ground

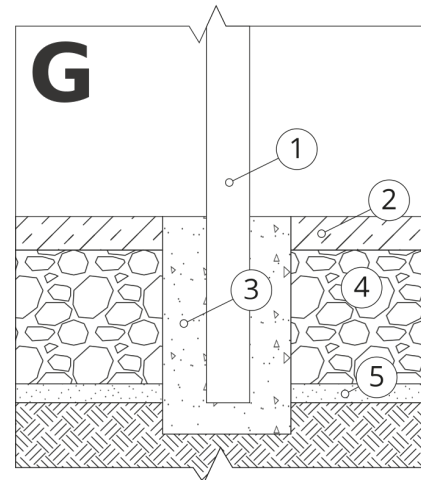

MOUNTING TO CONCRETE FOUNDATION

Description of the assembly

1. ZANO product
2. Fixed hardened surface e.g. concrete or asphalt
3. Concrete foundation, class C16/20 (top surface concrete 10 cm below paving surface)
4. Stone aggregate substructure
5. Sand ballast (approx. 2 - 4 cm)
6. Ground

NOTE: The drawings do not reflect the actual dimensions of the foundation. They are only exemplary assembly schemes taking into account the type of anchoring and the substrate material to which the furniture is to be fixed.

The size of the foundation depends on the local foundation conditions.

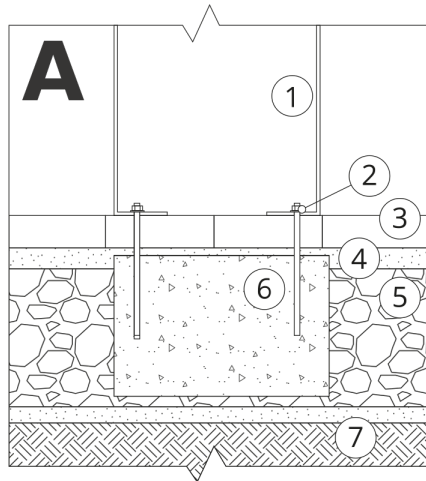

INSTALLATION INTO PAVING WITH FOUNDATION

Description of the assembly

1. ZANO product
2. Quick-action fastener or chemical anchor
3. Stone paving / concrete paving / stone slabs / concrete slabs
4. Sand ballast (approx. 2 - 4 cm)
5. Stone aggregate substructure
6. Concrete foundation, class C16/20 (top surface concrete 10 cm below paving surface)
7. Ground

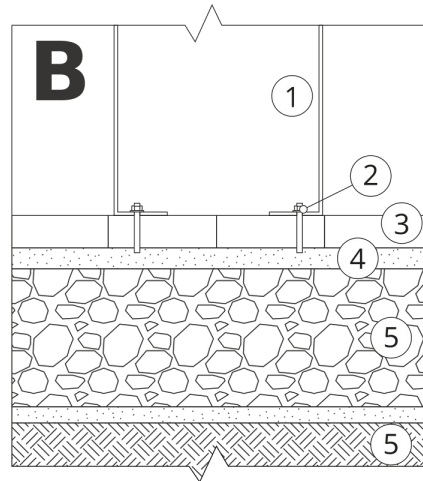

INSTALLATION TO PAVING

Description of the assembly

1. ZANO product
2. Quick-action fastener or chemical anchor
3. Stone paving / concrete paving / stone slabs / concrete slabs
4. Sand ballast (approx. 2 - 4 cm)
5. Stone aggregate substructure
6. Ground

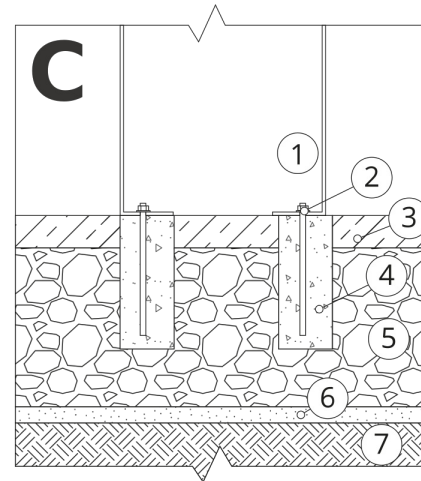

CONCRETE / ASPHALT MOUNTING

Description of the assembly

1. ZANO product
2. Quick-action fastener or chemical anchor
3. Fixed hardened surface e.g. concrete or asphalt
4. Concrete foundation, class C16/20 (top surface concrete 10 cm below paving surface)
5. Stone aggregate substructure
6. Sand ballast (approx. 2 - 4 cm)
7. Ground

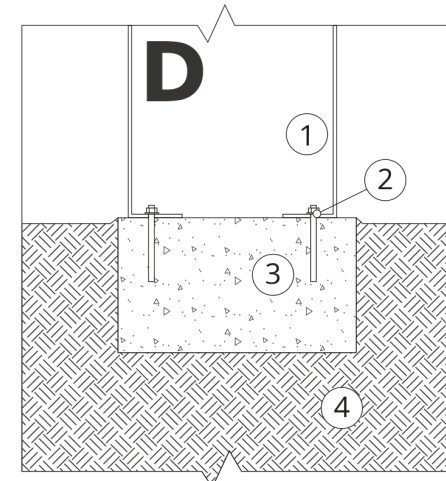

MOUNTING TO CONCRETE FOUNDATION

Description of the assembly

1. ZANO product
2. Quick-action fastener or chemical anchor
3. Concrete foundation, class C16/20 (top surface concrete 10 cm below paving surface)
4. Ground